



BATTERY OPERATED PATIENT LIFT
MODEL: 650HD

OWNER'S MANUAL



Thank you for choosing ApexLift[®]!

To better serve you, please record the following information:

Supplier Name: _____

Telephone: _____

Serial #: _____

Date of Purchase: _____

INSPECT YOUR MERCHANDISE

Upon receipt of your ApexLift[®], verify that all merchandise is complete and free from any shipping damage. Refuse delivery if the packaging appears to be badly damaged. If the merchandise is received damaged or is missing components, contact the shipping company immediately and file a claim.

For further assistance, contact your local dealer or Apex Dynamics Healthcare Products, L.L.C.

EXPLOSION CHART OF APEXLIFT[®] 650HD



1. BOOM
2. SPREADER BAR
3. ACTUATOR
4. MAST
5. BASE

DIAGRAM OF CONTROL BOX

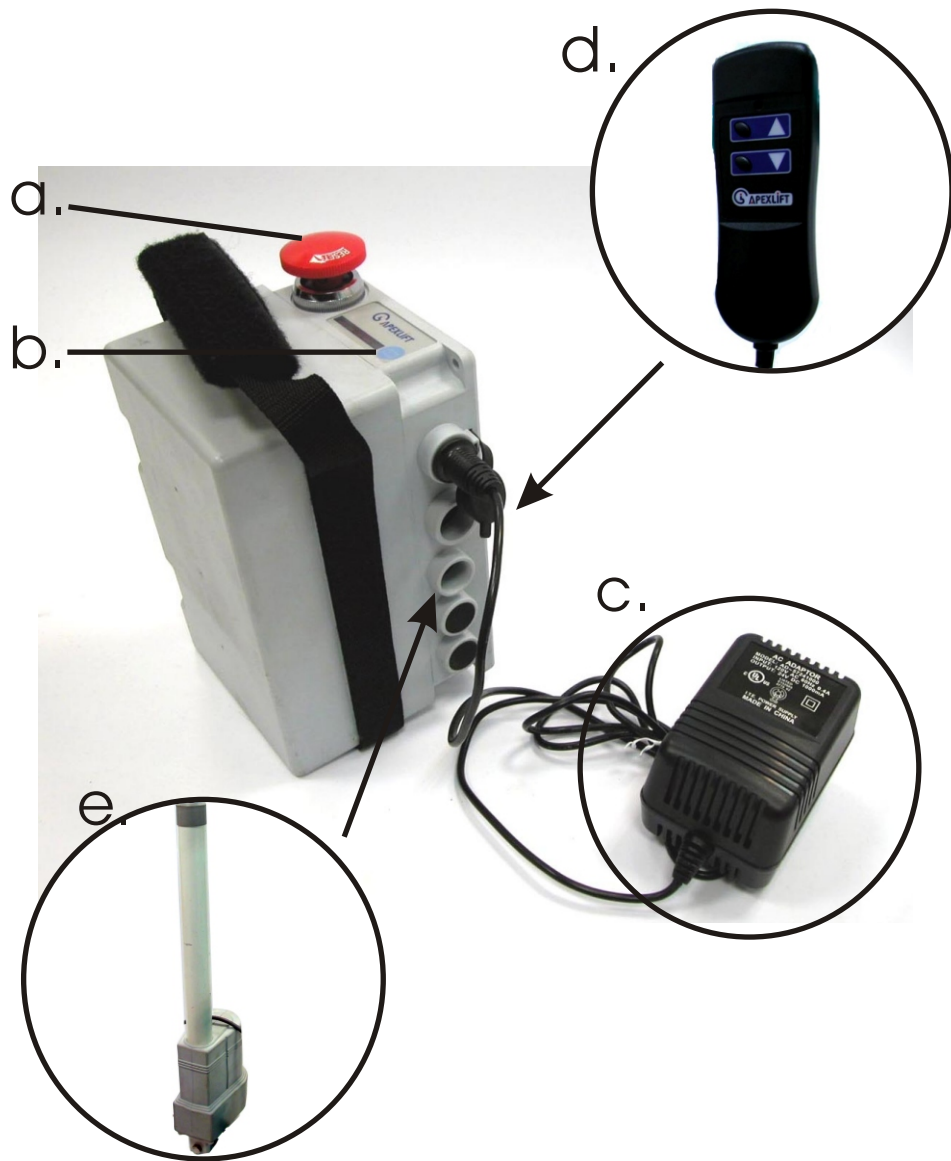

- a. Emergency Stop Button.
- b. Battery Testing Button.
- c. Charger Plug-in.
- d. Handset Plug-in.
- e. Actuator Plug-in.

SAFETY INSTRUCTIONS

The ApexLift[®] 650HD reflects innovative state of the art design to increase user mobility. The 650HD will provide years of service if it is properly maintained as any piece of electrical/mechanical equipment requires.

Please pay careful attention to the following important information regarding the care, maintenance, and operation of the ApexLift[®] 650HD Battery Operated Patient Lift. Carefully read these instructions before assembling the lifter, or attempting to lift any user with the device.

PLEASE NOTE THE FOLLOWING:

- Special care must be taken with users/patients who cannot themselves provide assistance while being lifted. (i.e. patients who are comatose, spastic, agitated, or otherwise severely handicapped.)
- The ApexLift[®] 650HD should be used solely for transferring a user/patient from one utility (beds, bathtubs, toilets, etc.) to another. The patient lift should not be used for transporting or moving any patient from one location to another location.
- During lifting or lowering, whenever possible, always keep the base of the lift in the widest position.
- The base of the lift should be closed before moving the lift.
- Do not roll casters over any object while the user/patient is in the sling.
- While being lifted in a sling, always keep the user/patient centered over the base and facing the caregiver operating the lifter.
- Maximum weight that can be safely lifted is 600 pounds.

The ApexLift[®] 650HD lift allows a person to be lifted and transferred safely with minimum physical effort provided by the caregiver. Before attempting to lift anyone, please

practice operating the lift. Also prior to actual lifting, explain the lifting procedure to the user/patient.

WARNING!

Do not attempt to transfer a patient without prior approval of the patient's nurse. Also, do not transfer without having studied the instructions and practiced operating the product several times. Together with the patient's doctor, nurse, or medical attendant, select an ApexLift[®] sling that is both practical and comfortable. The sling selected should be one that serves the needs of the patient, while providing the patient with optimal safety. Never interfere with the lift, unless instructed by the attendant. Have a doctor, nurse, or medical attendant (experienced in the use of the ApexLift[®] 650HD) present during the first few times the lift is used to transfer a new user.

WARNING!

ApexLift[®] slings are specially designed for ApexLift[®] equipment. Do not use slings manufactured by other companies with any ApexLift equipment. **USING NON-APEXLIFT[®] SLINGS ON APEXLIFT[®] EQUIPMENT IS UNSAFE AND MAY RESULT IN SERIOUS INJURY TO USERS AND CAREGIVERS.** Apex Dynamics Healthcare Products, L.L.C. is not responsible for any consequence resulting from the use of non-ApexLift[®] slings on ApexLift[®] equipment.

WARNING!

ApexLift[®] slings are specially designed for ApexLift[®] equipment. Do not use ApexLift[®] slings with non-ApexLift[®] equipment. **USING APEXLIFT[®] SLINGS ON NON-APEXLIFT[®] EQUIPMENT IS UNSAFE AND MAY RESULT IN SERIOUS INJURY TO USERS AND CAREGIVERS.** Apex Dynamics Healthcare Products, L.L.C. is not responsible for any consequence resulting from the use of ApexLift slings on non-ApexLift[®] equipment.

WARNING!

Do not put anything (e.g. cushion, pad, etc.) between the user and the sling. This may cause the user/patient to slide out of the sling and cause injury.

WARNING!

Avoid personal injury by making sure no children or pets are near the ApexLift[®] 650HD while it is in motion.

WARNING!

Avoid personal injury by making sure all extremities (such as fingers, arms, legs, or feet) are clear of the lift mechanism while it is in operation.

WARNING!

Avoid personal injury and possible damage to the 650HD by making sure the maximum weight limit of 400 lbs. is not exceeded.

WARNING!

Replace any worn parts with only genuine ApexLift[®] parts. ApexLift[®] parts are not interchangeable with parts from other patient lift brands. Using other patient lift parts on ApexLift[®] products is unsafe and may result in serious injury to user and caregiver. Apex dynamics healthcare products, l.l.c. is not responsible for any consequence resulting from the use of non-apexlift[®] parts and components.

WARNING!

Avoid personal injury by making sure the electrical connector is disconnected before conducting any electrical inspection. Contact your dealer if any electrical problem is detected.

WARNING!

Service and repair of ApexLift[®] equipment should be performed only by Apex Dynamics Healthcare Products, L.L.C. or by an authorized dealer. Apex Dynamics Healthcare Products, L.L.C. is not responsible for any consequence resulting from any unauthorized service or repair.

CAUTION

Avoid damage to the 650HD by keeping foreign objects from coming into contact with the lift mechanism.

NOTE

Arrange all necessary items (lift, slings, commode chair or wheel-chair) for a smooth procedure. The user/patient being transferred should be positioned in the center of the bed before being lifted, as well as when he/she is returned to the bed. Keep lifter base widened and brakes locked during lifting.

INSTALLATION INSTRUCTIONS

WARNING!

The lift is heavy. Therefore, avoid injury and **DO NOT** attempt to remove the lift from the box without any assistance.

1. Stand Mast from base

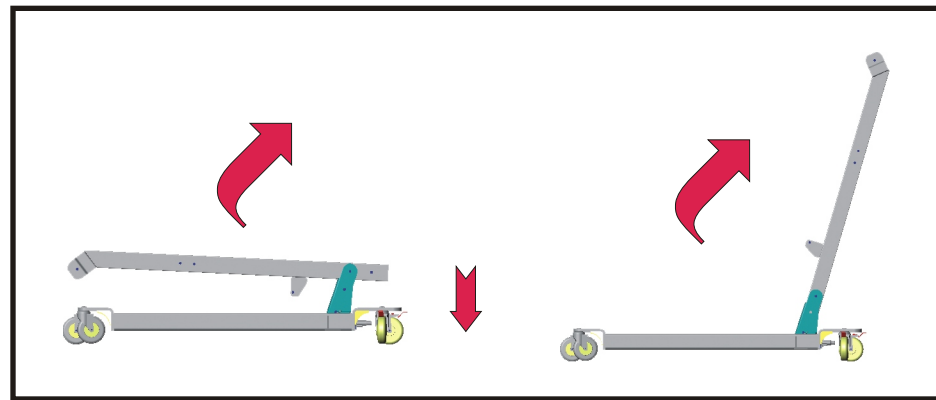

2. Tight mast to base with bolts and nuts provided

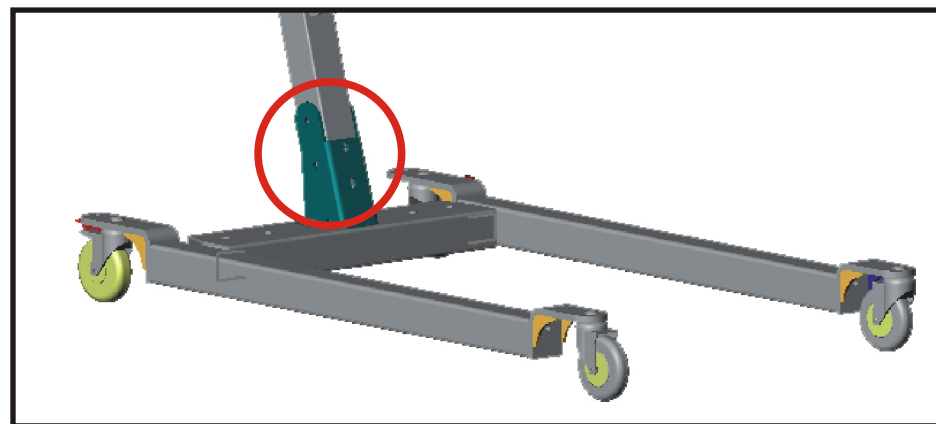

3. Attach boom to top of mast

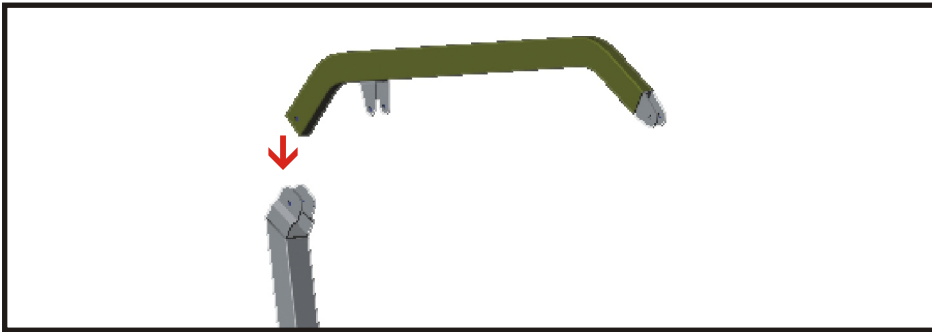

4. Attach spreader bar to front of boom

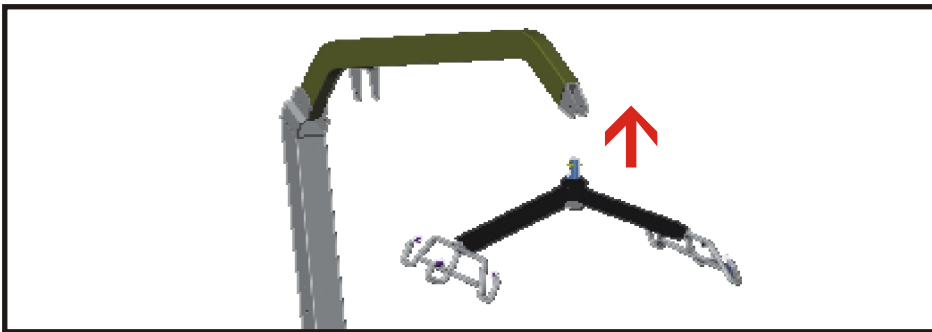

5. Attach Actuator to mast and boom

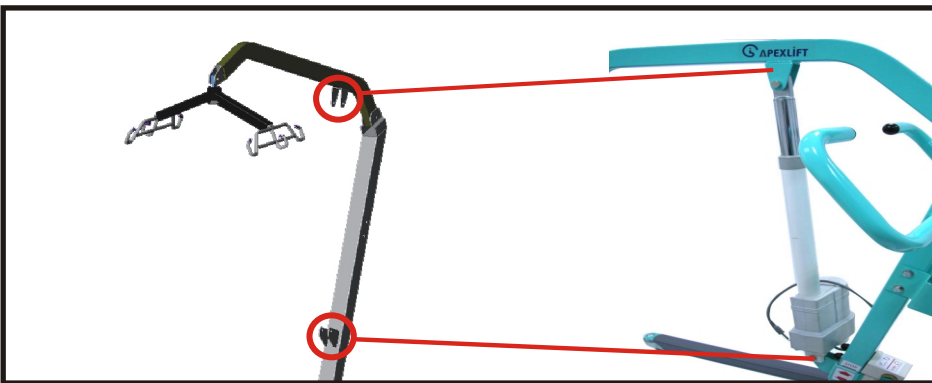

MAINTENANCE & INSPECTION CHECKING LIST

The operator of the lift is to inspect the ApexLift[®] 650HD before each use. Check all bolts for tightness. Make sure the base can be easily widened, and that all lift parts are in place. Make sure all casters turn freely, and that the caster brakes can be engaged. Make certain all necessary items (i.e. slings, wheel chairs, etc.) are accessible and ready for use.

Check the battery capacity. See instructions below.

At least once a month, the lift should be thoroughly inspected by a person qualified to recognize any signs of wear, and looseness of bolts or parts. Replace any worn parts immediately.

To lubricate, place a drop of oil on the following points when the ApexLift[®] 650HD is serviced and every month thereafter- Top of Mast, Spreader Hinge, and Caster Axles.

CHECKING BATTERY CAPACITY

Check batteries by pressing the Battery Indicator (blue circle with a battery sign). The status of the battery is indicated by LED lights and is listed in the following table:

RED	AMBER	GREEN	GREEN	GREEN	STATUS
ON	ON	ON	ON	ON	FULLY CHARGED
ON	ON	ON	OFF	OFF	NEEDS CHARGE
ON	ON/OFF	OFF	OFF	OFF	CHARGE IMMEDIATELY. DO NOT USE THE LIFT.
OFF	OFF	OFF	OFF	OFF	BAD BATTERIES OR BAD CONNECTION

CHARGING THE BATTERIES

- Make sure the battery box power switch is " ON " (i.e. the red button is up).
- Insert the charger into the charging socket on the battery box (the top slot).
- Plug the charger to the power supply.
- All LED indicator lights should be "ON" while charging.
- When one green LED indicator light is illuminated, the batteries require approximately 2-3 hours to be fully charged.
- When only the red LED indicator light is illuminated, the batteries require approximately 7-9 hours to be fully charged.
- Do not charge the batteries over 12 hours
- Unplug the charger FIRST before using the lift. THE APEXLIFT[®] 650HD WILL NOT OPERATE WHILE THE BATTERIES ARE BEING CHARGED.
- Replace the batteries when frequent charging is

WARNING BUZZERS

The control box has a buzzer that provides you with information on the status of the batteries and the lift. To stop the buzzer, push down the RESET button or press the Battery Indicator.

BUZZER TYPE	STATUS	NOTE
2 beeps per second	Low Battery (red/amber lights)	Charge batteries immediately.
3 beeps per second	Low Battery (red light on)	Charge batteries immediately.
6 beeps per second	Very Low Battery (no light on)	Charge batteries immediately.
3 beeps every other second	Bad Battery (no light on)	Replace batteries.
3 long beeps	Overloaded. Batteries are charged but lift does not lift.	Maximum load capacity exceeded.

Important Notes On Charging

Push lift to an appropriate location and charge the batteries with the charger provided. Avoid unplugging the hand control and motor from the control box. Frequent plugging and unplugging of the hand control and motor to and from the control box may damage the control box.

MAINTENANCE SCHEDULE

Item	In the Beginning	Monthly	Every 3 months
Boom & Spreader Bar: Check connections between 1) Boom and Spreader Bar and 2) Boom and Mast for improper connection, looseness, or wear. Check the Boom for bending and deflection.	●	●	
Mast: Check the Mast for bending or deflection. Check the steering bar for damage or loose screws.	●	●	
Base & Foot Peddle: Check bolts and nuts for looseness. Check casters and axle bolts for tightness. Check rubber parts on the casters for deflection. Apply grease to caster ball bearings if needed.	●	●	●
Cleaning: As needed.			●
Actuator & Control Box: Make sure the control box is firmly affixed to the mast. Make sure the pins are firmly affixed the actuator to the Boom and the Mast. Make sure the connecting cable of the actuator and the control box is not loose. Make sure the Battery Indicator has least 2 green LED lights illuminated prior to use.	●	●	

Item	In the Beginning	Monthly	Every 3 months
Slings & Sling Hardware: Check sling for wear. Check sling hardware each time before use.	●	●	

OPERATING INSTRUCTIONS

NOTE: Turn the lift "ON " by turning the red " RESET " button clockwise. Turn the lift " OFF " by pressing down the " RESET " button.

Transfer From Bed

- User/patient should be in the center of the bed.
- Position user onto his/her side by rolling user towards you.
- Roll the sling in half, approximately. The handle on the back section should face outward when the sling is fitted.
- Position the sling under the user/patient so the commode aperture aligns with the base of the spine and top of the sling close to the neck.
- Roll user onto the opposite side and position him/her on the flat section of the sling. This will allow you to unroll the remainder of the sling from the other side of the user.
- Once the sling has been positioned centrally, feed the leg sections under the thighs and draw them up between the thighs.
- Raise the head of the bed if this function is available.
- Move the lift slowly towards the user and position the spreader bar over the user's/patient's chest.
- Attach Loop A of the sling to Hook A on Spreader Bar; attach Loop B to Hook B; attach Loop C to Hook C; attach Loop D to Hook D.

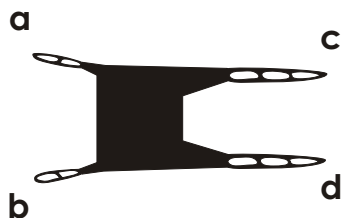

-16-

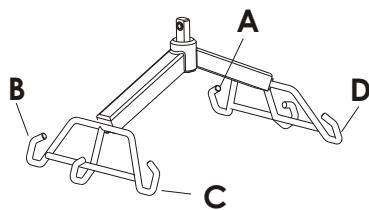

- Lift the user above the bed by using the hand control.
- Pull lift away from bed. Position user over the wheelchair or chair then lower the patient onto the surface.

Note: Reverse the above procedures when returning the user/patient to bed.

Transfer From Wheelchair

- Grasp the sling at each corner of the "U" shape of the commode aperture.
- The sling should be fitted with the handle on the back section facing outward.
- Help the user lean forward slightly, then slide the sling down between the chair and the user's back.
- Position the commode aperture where the buttocks meets the seat.
- Position the sling equally around both sides of the body.

Draw the leg sections to the front along the length of the user's thigh.
- Check the sling's central positioning by comparing the lengths of the leg sections when they are drawn forward.
- Reposition the sling if the leg sections are not equal in length.
- Feed the leg sections under the thighs.
- From between the legs, gently pull the leg section up the inner thigh.

-17-

- Feed as much material as possible under and between the thighs. Ensure the leg sections are positioned midway under the thighs to provide good support and greater comfort.
- Move the lift slowly towards the user and position the spreader bar over the user's chest.
- Attach Loop a of sling to Hook A on Spreader Bar; attach Loop b to Hook B; attach Loop c to Hook C; attach Loop d to Hook D.
- Lift patient above the wheelchair by using the hand control.
- Pull lift away from wheelchair. Position patient over bed and lower patient onto it.

Note: Reverse the above procedures when returning the user/patient to a wheelchair.

WARNING!

Use ONLY ApexLift[®] slings/products with ApexLift[®] equipment.

TROUBLE SHOOTING

Symptom:	Corrective Action:
Cannot lift patient up and battery indicator shows no GREEN light.	1. Charge the batteries until all green lights are on.
Lift does not work and the battery indicator shows a full charge.	1. Check connection between the actuator and the control box. 2. Check connection between the pendant & control box. 3. Contact your dealer if problem persists.
Lift does not work and the battery indicator shows no light.	1. Make sure the emergency stop button is released. 2. Check connection of the batteries in the control box. 3. Contact your dealer if problem persists.
Stops-and-Runs while lifting or lowering user.	1. Check socket for pendant plug-in. 2. Check pendant cable. 3. Charge the batteries. Replace bad batteries. 4. Contact your dealer if problem persists.
Battery Indicator shows no light when charger is connected to power supply.	1. Check if emergency stop button is released. 2. Check charger plug for damage. 3. Check charger cable for damage. 4. Replace bad batteries. 5. Contact your dealer if problem persists.

If there is problem you could not correct, please contact the dealer for assistance.

LIMITED WARRANTY

The ApexLift[®] 650HD you purchased is guaranteed by Apex Dynamics Healthcare Products, L.L.C. (" Apex Dynamics ") to be free from defects in material and workmanship under normal use and service. The warranty period for this product is twelve (12) months from the date of purchase by the original purchaser, excluding the batteries, which are warranted for six (6) months only. This warranty shall be voided upon transfer of ownership of this product. Apex Dynamics agrees to repair or replace this product, at our discretion and at no charge, within the warranty period provided the product is delivered to Apex Dynamics or its Authorized Service Center in its original packaging or equivalent; is fully insured with all shipping charges prepaid; and that Apex Dynamics consents the unit is defective. The repaired or replacement unit shall be warranted for a period equal to the balance of the defective unit's warranty period. A handling charge of \$50.00 will be applied to any returned product proven to be not defective. For warranty service, please contact the dealer from whom you purchased your ApexLift[®] product. You may also contact Apex Dynamics at **1-800-742-0453** should warranty service not be available from your dealer. NOTE: You must never return the product to your dealer or to Apex Dynamics at any time without the verbal consent of either party. To ensure the best service to our customers, Apex Dynamics requires the following information to be included with the returned unit:

1. Model Name/Number and Serial Number on the packaging.
2. Proof of purchase, i.e. a copy of the original invoice from either Apex or its dealer.
3. A Return Authorization number (RA#) obtained by calling Apex Dynamics prior to the return of the product. The RA# must be clearly indicated on the outside of the packaging;

4. A detailed description of the problem and its symptoms on a note.

This warranty shall not apply to any product which has been repaired or altered in any way so as, in our judgment, to affect its functionality and durability, nor to any product subject to abuse, misuse, negligence or accident, improper maintenance, improper installation, nor to any product used with other parts, components and/or accessories with quality and/or specifications not compatible with this product. This warranty does not cover products that have been impaired by occurrences considered Acts of God over which Apex Dynamics has no control. This warranty shall also be voided if any required periodic maintenance, if applicable, has not been properly performed on this product

This warranty and the aforementioned remedies presented are exclusive and in lieu of all other express or implied warranties. No other representations or claims shall be binding or obligate Apex Dynamics in any way. Any warranty applicable to this product is limited to the aforementioned period indicated. In no event shall Apex Dynamics be liable for any special, incidental, or consequential damages; loss of revenue; or cost of replacement goods; resulting from the use or malfunction of this product to the associated equipment on which and with which it is used. This warranty gives specific legal rights and you may be entitled to other rights that vary from state to state.

PLACE
STAMP
HERE



WARRANTY REGISTRAION CARD

Model Serial No. Date Purchased

Purchased From

Facility/User Name

Address

City State Zip

Tel: Fax:

e-mail Address:

Comments: